



**D60940 9 – 40 GHz 6-Way Power Divider/Combiner**

**FEATURES**

- ❖ Low VSWR
- ❖ High Isolation
- ❖ Small Package
- ❖ Light Weight



**SPECIFICATIONS**

<b>9 – 40 GHz 6-Way Power Divider/Combiner</b>	
Model Number	D60940
Frequency Range	9 – 40 GHz
Insertion Loss	3.90 dB Typ., 4.50 dB Max.
Isolation	17 dB Typ., 14 dB Max.
Input VSWR	1.45:1 Typ., 1.70:1 Max.
Output VSWR	1.40:1 Typ., 1.60:1 Max.
Amplitude Balance	±0.40 dB Typ., ±0.80 dB Max.
Phase Balance	±4.0° Typ., ±8.0° Max.
Power Handling as Divider	50 W CW Max.
Impedance	50Ω
Connector Type	2.92 Female (other connector available on request)

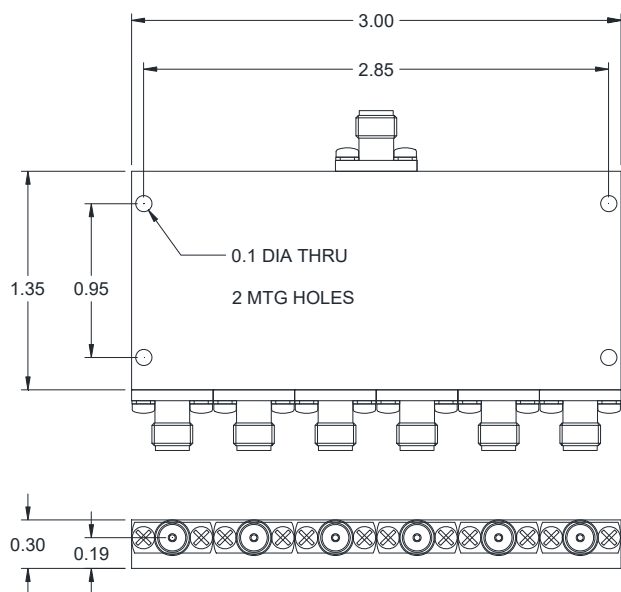

Design to meet the following environmental specifications: (verification optional)

1. Operating Temp: -55°C to +85°C
2. Storage Temp: -65°C to +125°C
3. Shock: MIL-STD-202F, M213, Cond B
4. Altitude: MIL-STD-202F, M105, Cond B
5. Vibration: MIL-STD-202F, M204, Cond B
6. Thermal Shock: MIL-STD-202F, M107, Cond A
7. Temp. Cycle: MIL-STD-202F, M105C, Cond D
8. Humidity: MIL-STD-202F, M103, Cond B  
(Optional with Hysol epoxy seal)

Standard Finishing: Rugged Aluminum Housing, optional finishing with blue epoxy paint per MIL-C-22750 available on request.

Note:

1. Insertion loss refers to the sum of the output power to the input power
2. Standard connector is 2.92mm female for all the ports
3. Other connector combination is available on request
4. Power handling is under the condition that all the outputs are connected to the loads with 1.25:1 or better VSWR and the unit is mounted with excellent heat sink