



HQ2506 2.5 – 6 GHz 3 dB 90° Hybrid

FEATURES

- ❖ Low VSWR
- ❖ Low Insertion Loss
- ❖ High Isolation
- ❖ Excellent Amplitude & Phase Tracking



SPECIFICATIONS

2.5 – 6 GHz 3 dB 90° Hybrid	
Model Number	HQ2506
Frequency Range	2.5 – 6 GHz
Insertion Loss	0.45 dB Typ., 0.60 dB Max.
Isolation	24 dB Typ., 21 dB Min.
Input VSWR	1.10:1 Typ., 1.25:1 Max.
Output VSWR	1.10:1 Typ., 1.25:1 Max.
Amplitude Balance	±0.15 dB Typ., ±0.25 dB Max.
Phase Balance	±1.5° Typ., ±3.0° Max.
Power Handling	80 W CW
Impedance	50Ω
Connector Type	SMA Female

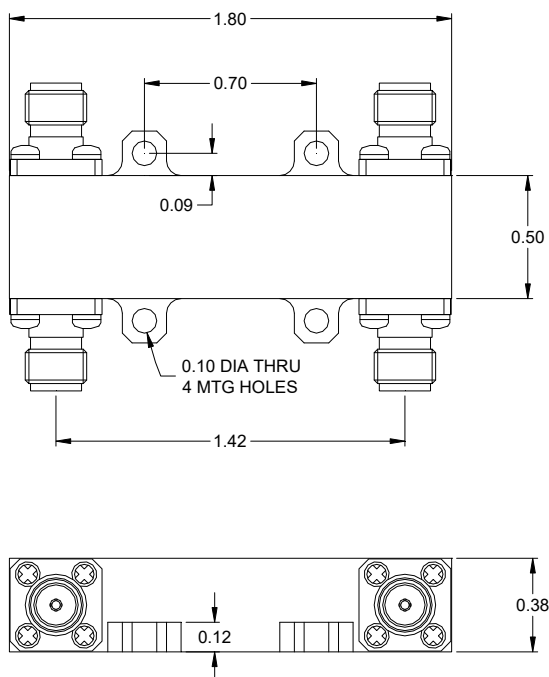

Design to meet the following environmental specifications: (verification optional)

1. Operating Temp: -55°C to +85°C
2. Storage Temp: -65°C to +125°C
3. Shock: MIL-STD-202F, M213, Cond B
4. Altitude: MIL-STD-202F, M105, Cond B
5. Vibration: MIL-STD-202F, M204, Cond B
6. Thermal Shock: MIL-STD-202F, M107, Cond A
7. Temp. Cycle: MIL-STD-202F, M105C, Cond D
8. Humidity: MIL-STD-202F, M103, Cond B
(Optional with Hysol epoxy seal)

Standard Finishing

Housing: Rugged Conductive Aluminum Housing
Connector Housing: Passivated Stainless Steel
Connector Center PIN: Beryllium copper, Gold plated

Note:

1. Insertion loss refers to the sum of the output power to the input power
2. The amplitude balance is the path loss variation over the average value of both paths
3. Other connector combination is available on request
4. Power handling is under the condition that all the outputs are connected to the loads with 1.25:1 or better VSWR and the unit is mounted with excellent heat sink