



KGK518N 5 KHz – 18 GHz N Connector DC Block

FEATURES

- ❖ Low VSWR
- ❖ Low Insertion Loss
- ❖ Broadband Coverage
- ❖ Mounting Hole Available



SPECIFICATIONS

5 KHz – 18 GHz N Connector DC Block	
Model Number	KGK518N
Frequency Range	5 KHz – 18 GHz
Insertion Loss	0.50 dB Typ., 0.70 dB Max.
Input VSWR	1.20:1 Typ., 1.35:1 Max.
Output VSWR	1.20:1 Typ., 1.35:1 Max.
RF Power Handling	2 Watt CW Max.
DC Voltage Handling	25 V
Impedance	50Ω Nom.
Connector Type	N

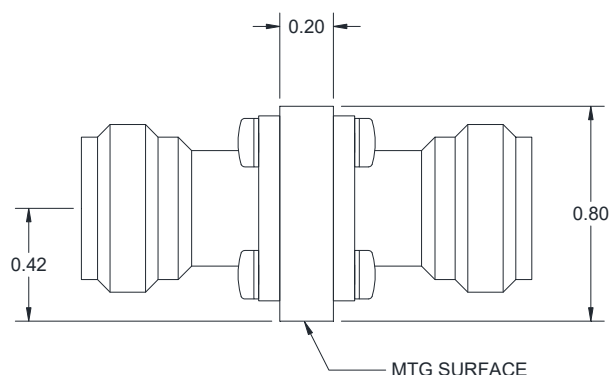
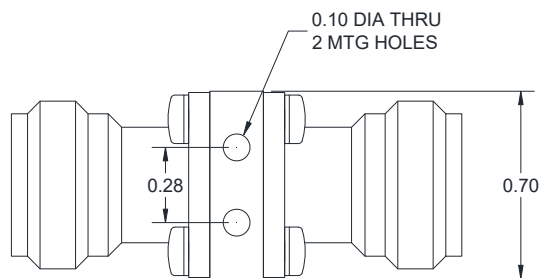

Design to meet the following environmental ratings:
(verification optional)

1. Operating Temp: -55°C to +85°C
2. Storage Temp: -65°C to +125°C
3. Shock: MIL-STD-202F, M213, Cond B
4. Altitude: MIL-STD-202F, M105, Cond B
5. Vibration: MIL-STD-202F, M204, Cond B
6. Thermal Shock: MIL-STD-202F, M107, Cond A
7. Temp. Cycle: MIL-STD-202F, M105C, Cond D

Standard Finishing: Rugged Aluminum Housing.
Optional finishing with blue epoxy paint per MIL-C-22750 available on request, meeting the humidity specification MIL-STD-202F, M103, Cond B

Note:

1. Inner type DC Block
2. Standard connector is N female
3. Part number for different N combination is as follow
Add "M" suffix for N male to male
Add "MF" suffix for N male to female
4. RF power handling is tested at 2 GHz under the condition that the unit is mounted with excellent heat sink